

STEEL TRUCK DOCKBOARD - TS-20-8460

APPROX WEIGHT: 787.53 lbs.
DOES NOT INCLUDE WEIGHT OF POWER OR PACKAGING!!!

*** ANY ADDITIONS, DELETIONS, OR OMISSIONS MUST BE CORRECTED ON THIS DRAWING AS THIS DRAWING WILL BE CONSIDERED ALL INCLUSIVE ***

ALL GRAPHICS PROVIDED ARE FOR REFERENCE ONLY. IF CERTAIN DIMENSIONS ARE CRITICAL PLEASE VERIFY THOSE DIMENSIONS WITH YOUR SALESPERSON

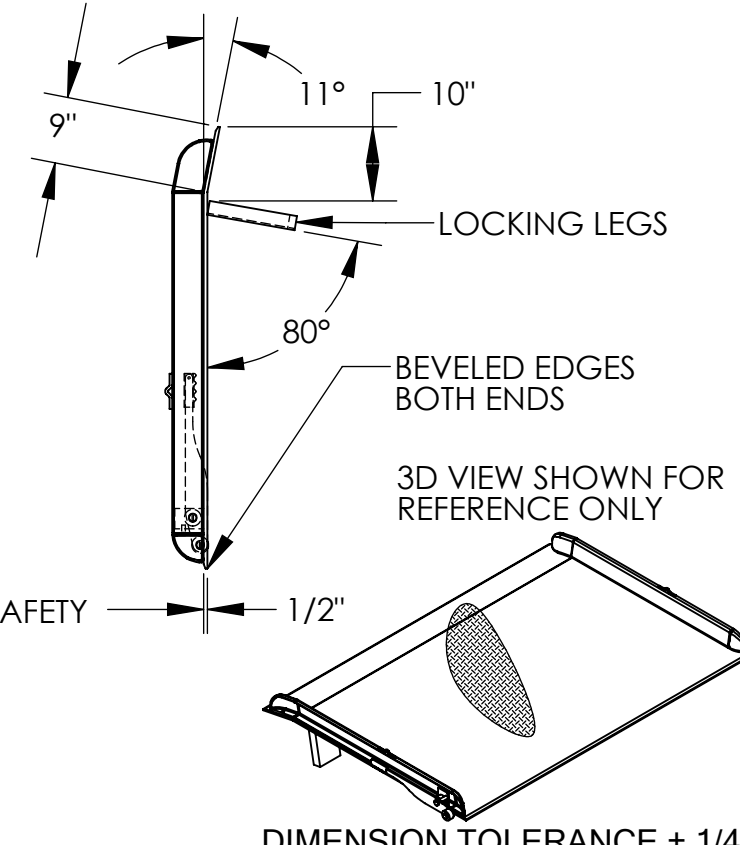
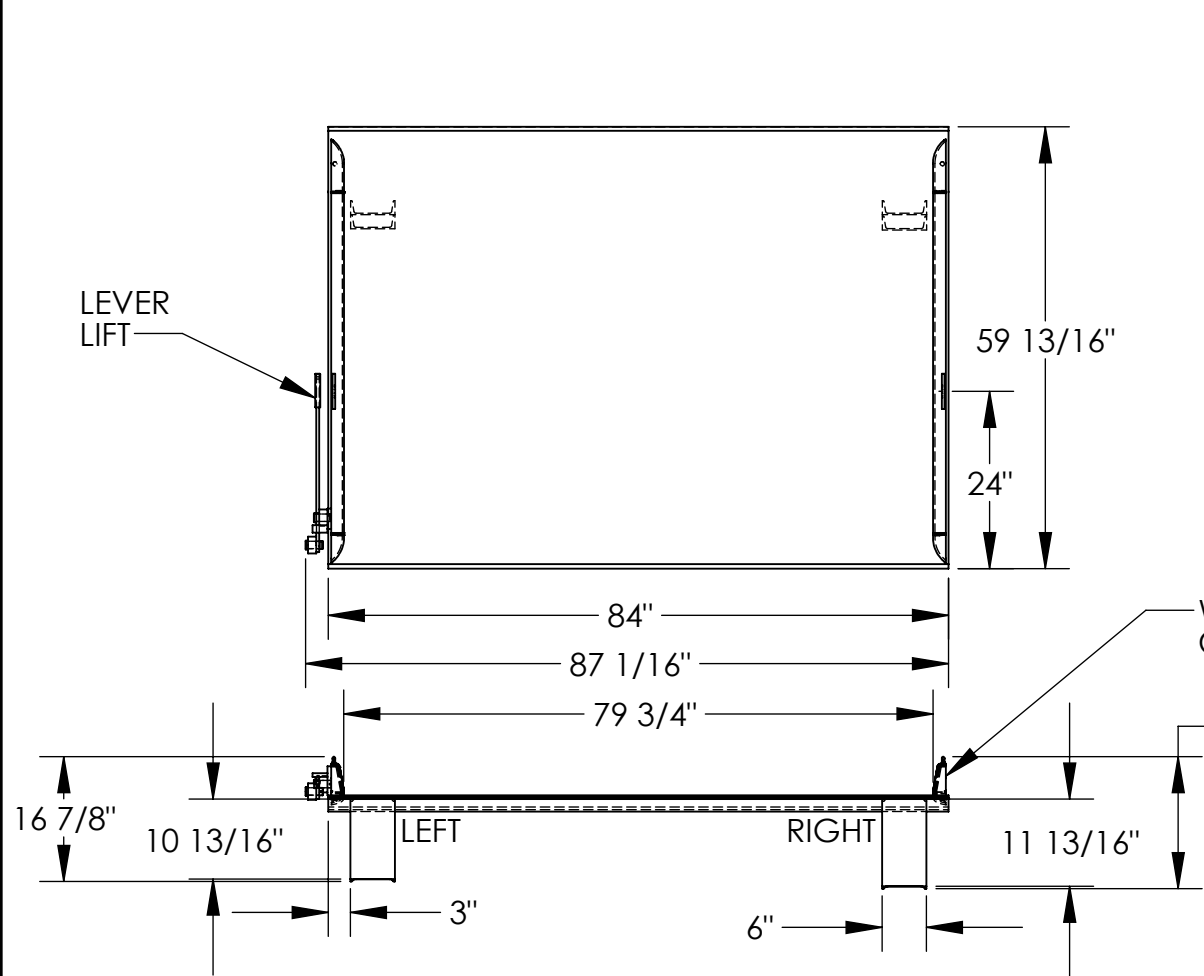

STANDARD FEATURES

- MODEL NUMBER: TS-20-8460
- CAPACITY: 20,000 LBS
- OVERALL WIDTH: 87 1/16"
- OVERALL LENGTH: 59 13/16"
- DOCKPLATE THICKNESS: 1/2"
- LEVER LIFT IS STANDARD
- LOCKING LEGS ARE 6" WIDE
- RIGHT LEG LENGTH IS 11 13/16"
- LEFT LEG LENGTH IS 10 13/16"
- CROWN IS 11° & 9" FROM EDGE
- HEIGHT DIFFERENCE: 10"
- DURABLE LIQUID PAINT BLUE FINISH

SPECIAL FEATURES

NONE

A P P R O V A L

I, THE UNDERSIGNED, AGREE THAT THE PRODUCT AS REPRESENTED SATISFIES DESIGN AND DIMENSION REQUIREMENTS. I ALSO ACKNOWLEDGE MY DUTY TO CONFIRM PRODUCT AND INSTALLATION COMPLIANCE WITH ALL APPLICABLE FEDERAL, STATE AND LOCAL REGULATIONS AND STANDARDS.

UNITS REQUIRING APPROVAL DRAWINGS OR MODIFIED ARE NON-RETURNABLE

[] As drawn [] As marked

Signed: _____ Date: _____

Printed Name: _____

LEAD TIME WILL START UPON RECEIPT OF SIGNED APPROVAL DRAWING

DISTRIBUTOR'S NAME:		P.O.#
VESTIL MANUFACTURING		X
DRAWN BY: ADL		W.O.#
DATE: 12/21/2005		X
REFERENCE: X	SCALE: 1:26	SALES: X
QUOTED LEAD TIME: X	QUOTE # X	FILE NAME: 10-007-095